

List Price \$9.98

Custom Cascade™

WELDING • SHEET METAL • FABRICATION

#1 Design

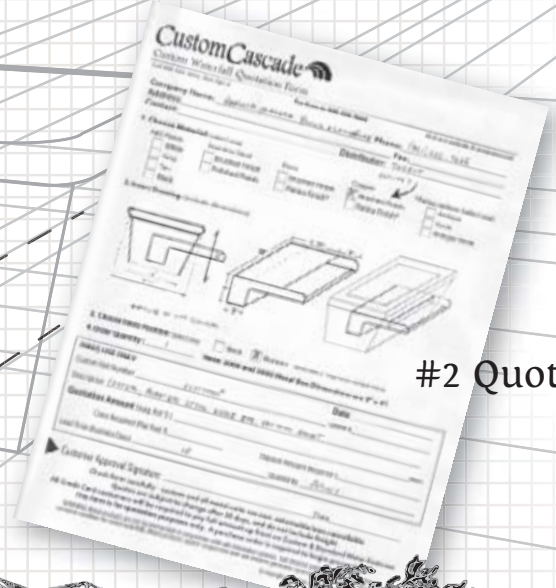
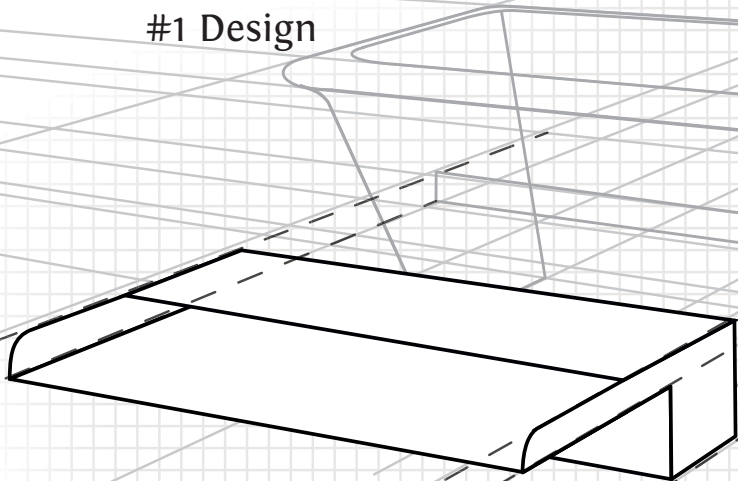

#2 Quote

#3 Build

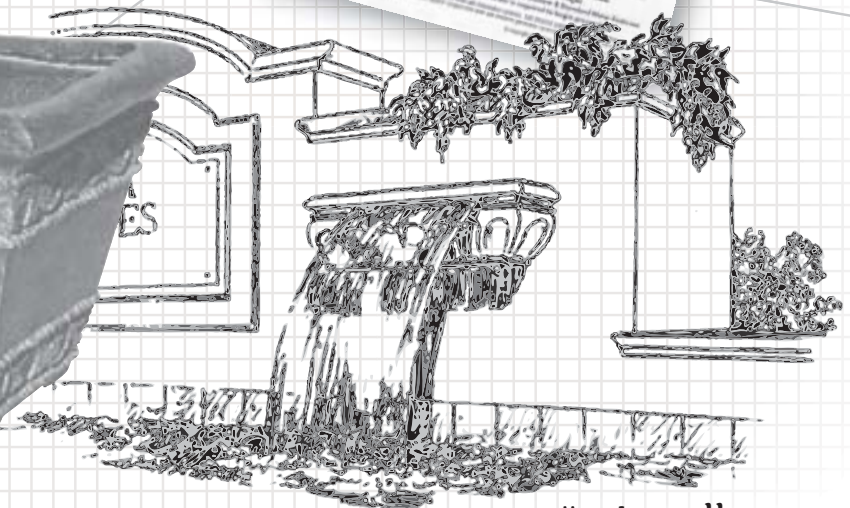
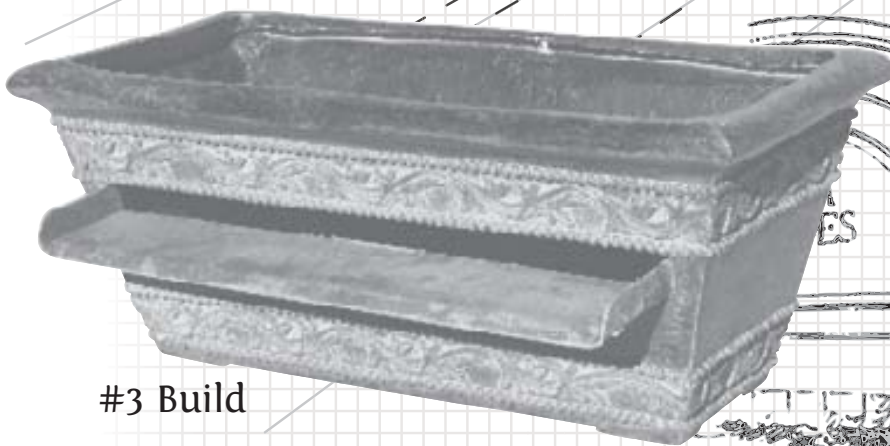

#4 Install

TECH & SPEC GUIDE

Custom Water Features - Concept To Finish

Custom Cascade™

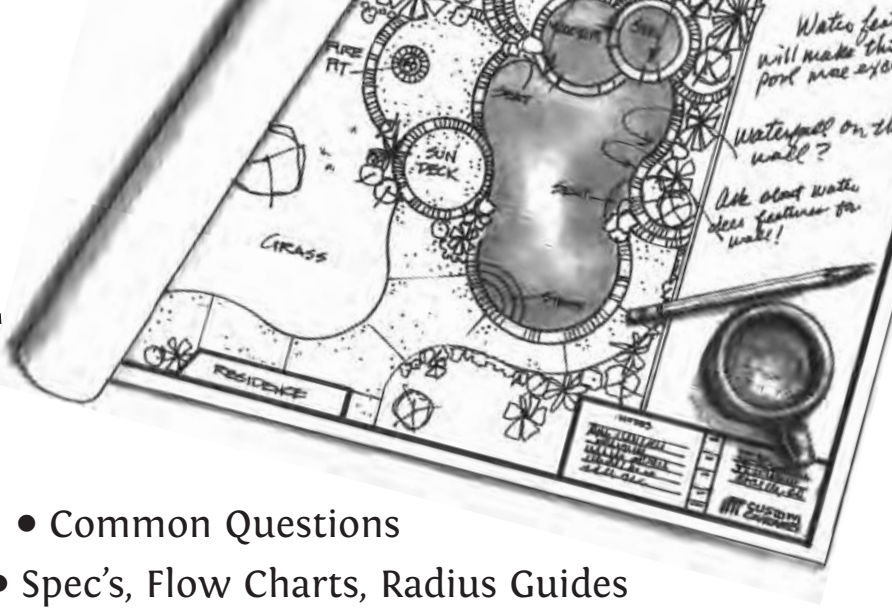

This Guide Contains:

- Important Facts
- How-To's
- Common Questions
- Technical Reference Material
- Spec's, Flow Charts, Radius Guides

The Smart Choice...

- Custom Cascade is the original manufacturer of the sheeting waterfall.
- We have the largest variety of standard units in the industry.
- We are the only manufacturer to offer products in ABS plastic or pure metal.
- We offer four colors of ABS plastic: white, gray, tan and black.
- Our metal waterfalls are available in Stainless Steel, Copper or Brass.
- Metal units use our exclusive Free-Flow baffle system, to eliminate internal blockage.
- ABS units feature a T-Baffle design that adds additional structural support.
- Our special order capabilities are almost limitless.
- Our staff is educated and ready to assist you.
- Our website includes beautiful photos, video and sounds that our waterfalls make. It also includes tools for consumers to locate qualified Custom Cascade builders.



Custom Cascade ArcFalls shown above.

FREQUENTLY ASKED QUESTIONS:

What size pump do I need?

There are many variables that are involved in finding the correct answer, such as distance from the pump to the waterfall, piping size, and number of 90 degree angles in the plumbing, etc. We can tell you the gallons per minute (gpm) that our waterfalls require. It varies from 5 gpm to 30 gpm. Please refer to the flow charts provided for this information (Page 13 - Page 15).

How do I figure the radius?

A radius is calculated by taking the diameter of a circle and dividing it in half. We can also calculate the radius by using the straight edge measurements from point to point of the front of the waterfall and the measurements of the greatest difference from the center of the fall. If this information is not available or the radius is compound, a template can be made of paper or cardboard. Refer to our "How to Cut a Template" on the On-Site Construction Know How Guide (Page 6).

What is the largest waterfall you can make?

Our metal series waterfalls can be made to any length in most scenarios. Our plastic waterfalls can be partially constructed on-site by a factory representative providing lengths beyond 20 feet for both rainfalls and waterfalls including straight, radius, curved vessels, or compound radius units. Challenge us...

How many inlets are on the waterfall?

This is another question that has many variables for the answer, such as what type of waterfall you are purchasing. Please refer to the inlet charts provided for the answers (Page 16 - Page 17).

Can a waterfall be lit?

Yes. Disrupted water reflects light much better than a solid sheet of water, so we recommend using RainFalls or RainCurtains for the best effect. Water features are best accented by using up lighting 12" to 18" below the water, or down lighting from the underside of the fall. Both options are made possible by using either fiber optics, LED or incandescent products.

Can an ABS plastic waterfall be painted?

Yes, but we feel choosing either our tan or gray waterfall color is the most simple, permanent and affordable solution to blending the waterfall into the pools environment. If you choose to paint, epoxy paint works the best. Be aware like any other painted surface, it will require maintenance.

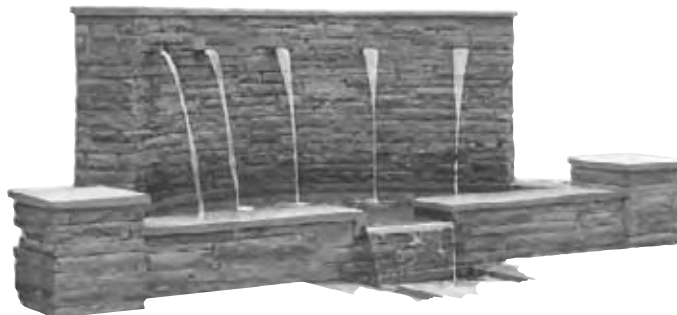

Custom Cascade Channel Spouts and SpillEdge featured above.

Remember this is basic information, designed to be used as a guideline only. Your specific jobs may need adjustments.

AVOIDING PROBLEMS...

- Know the correct gpm required for your applications. This is the most common mistake encountered. More water, valved, is always better than not enough water. See flow charts provided in technical reference for details (Page 13 - Page 15).
- Blow the lines clear of debris before attaching the waterfalls.
- Follow "How to Cut a Perfect Radius" instructions completely when cutting a waterfall on site. See "On-Site Construction Know How" for detail (Page 6).
- DO NOT leave plastic waterfalls in direct sunlight or hot temperatures. If needed, see "On-Site Construction Know How" for details on repairing a warped waterfall (Page 6).
- Know the maximum elevations waterfalls can maintain a sheeting drop before the water breaks up. See "Flow Charts" provided for details (Page 13 - Page 15).
- Know your radius and the lip requirements. See "Radius Lip Sizing Chart" for details (Page 9).



- Do not install stainless steel units in pools or water features with salt chlorine generators. We recommend copper, brass or ABS plastic.
- Keep debris off all waterfalls, especially stainless steel. Surface debris can settle and form surface rust if left unattended. See "Owners Guide for Waterfall Care" instructions. (Page 5)
- Provide the consumer with information in regards to the variety of sounds different water features make. Choose a location that makes best use of natural sunlight to capture that shimmering look. Visit our website, oreqcorp.com for this information and details.
- Provide the home owner with the "Owners Guide to Waterfall Care" instructions provided with each waterfall. (Page 5)

TECHNICAL REFERENCE MATERIAL...

Creating a Wet-Wall Effect:

There are many variables to creating a wet-wall effect. The most important element is knowing the desired effect of water flow. Variances range from a smooth, almost splashless flow down a smooth material such as glass, to a rushing flow of white water. In all applications, a leak-proof, even disbursement of water at the top of the fall is a basic requirement. This can be achieved using Custom Cascade waterfalls. To keep the water on the surface of the wall, the water manifold should be installed 1/2" to 1" behind the surface wall. This also keeps the water supply hidden. Water flow requirements range from 3 gpm to 7 gpm in most applications. Textured surfaces will need to be reclined at 3° to 7° to keep the water in contact with the surface. No matter how rough the surface, the water will not run "white" until it gets up to speed, approximately 8" from the top of the fall.

Calculating Basin Size:

7.5 gallons of water fits in one foot of space. One cubic foot of space is calculated by $12" \times 12" \times 12" = 1728"$. The general rule for required water in the reservoir tank is 3 times the amount of the water needed to make the waterfall function properly. For example, if the waterfall needs 30 gpm, then the reservoir tank must hold 90 gallons of water.

Example: Take 90 gallons, then divide by 7.5 = 12 cubic feet of space needed in the basin to operate correctly.

Reservoir length must be 2' longer than the waterfall (12" on each side).

Width of reservoir must be 1/2 the height of the waterfall. For example if a 4' waterfall is placed 4' up, the reservoir must be minimum of 8' long and 2' wide. (front to back).

Calculating Water Capacity in a Basin:

Lets say we have a reservoir tank that measure 12" H x 7" W x 48" L (you must convert all measures to inches).

1. Multiply $12 \times 7 \times 48 = 4032$ cubic inches.
2. Divide that by 1728 (one cubic foot)
3. Equals 2.33 cubic feet in this case.
4. 7.5 gallons fits in one cubic foot so $7.5 \times 2.33 = 17.475$ gallons fits in that size of reservoir tank.

Converting a Waterfall to a RainFall:

Is it possible to convert some plastic waterfalls to rainfalls after installation?

Yes! For complete details and assistance call our customer service department at 800-420-3255. Dial Opt. 2.

Remember this is basic information, designed to be used as a guideline only. Your specific jobs may need adjustments.

OWNERS GUIDE TO CARING FOR YOUR WATER FEATURE

Custom Cascade Waterfall Maintenance

For ABS Plastic Units:

For perfect sheet like flow, keep debris out of lip area. If the water flow becomes broken, chances are some type of debris is lodged in the front of the lip area. Simply use the enclosed rock pick or a credit card and slide it across the front of the fall.

Be careful to avoid hitting the support ribs that are set 3/4" back from the lip opening. Ribs must be kept straight and in place for appropriate flow.

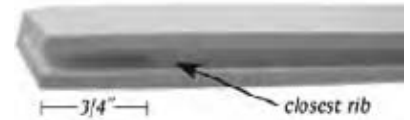

For Metal Units:

Our **stainless steel** units are made with the highest grade of metal available. To keep debris from settling on the lip area, the waterfalls should be wiped down with a clean cloth periodically. When minerals or chemicals settle on the unit over a period of time, surface rust may develop. If this occurs, a scotch brite pad can be used to rub it off. It is important to use long, single strokes, parallel to the lip. This process may dull a stainless steel brushed finish, leaving a pewter type look. It will not compromise the quality of the metal.

Our **copper or brass** waterfalls are made with pure high quality metal. It is the natural process for these metals to patina or change surface colors over time. You may see browns, greens, blue or even purple colors in a large variety of patterns. This distinctive and exquisite look will continue to change over time. If you should choose to keep the brushed metal look (no patina) you can do so by using a Scotch-Bright® pad. Again, even strokes, staying parallel with the lip. As with any metal, the results of a polish/patina will create a variety of effects based on the grade of the cloth or scrubbing pad and the amount of pressure applied.

Your waterfall is designed with little to no maintenance in mind. It is our hope that you enjoy the soothing sounds and find its shimmering water playful and inviting.

We sincerely hope your water feature brings you and your family refreshing fun and beauty for your pool. Our family has been in the swimming pool industry for over 40 years. It is our experience and attention to detail that creates the finest quality products for your swimming pool.

Visit our website for your complete pool care and fun at www.oreqcorp.com; including PoolPals™, XCalibur™ Pro, ZifFun™, Custom Cascade™ and ClearView™. You will find unique items, all made with quality and high standards you can count on.

Your pool was built for relaxation, fun, health and beauty. Please remember to always enjoy your swimming pool safely. Never leave any child unattended even for a moment.

ON-SITE CONSTRUCTION KNOW-HOW

How To Cut a Perfect Radius:

(for ABS plastic waterfalls 2000 series and higher only)

1. Use #10 coarse tooth jigsaw blade for initial cut. Make the cut quickly to avoid melting the ABS plastic.
2. Smooth out with hand plane.

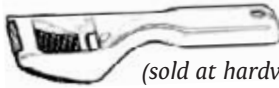

(sold at hardware stores, looks like a cheese grater)

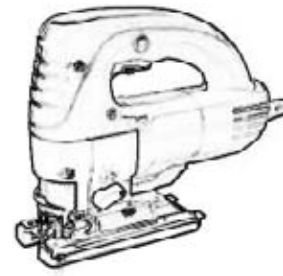

3. Remove the rib section closest to the lip by using the rib tool. Grasp the end of the rib and gently move it left to right. Rib section will break off in 8 - 10 moves. Rib must be set back 3/4" for appropriate flow.



Rib Tool

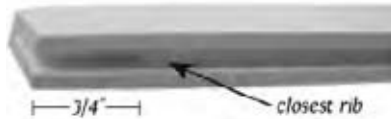

4. Finish with 80 grit sand paper, clean any debris from the lip area.
5. Quickly swab front of lip with appropriate glue solvent to seal.
6. If you should need to replace any broken ribs, they can be re-set inside the lip using the rib tool and glue. Ribs MUST be set straight for appropriate flow.

How to Make a Template for Radius Cuts:

1. Use paper or cardboard for best results.
2. Lay material down FLAT on top of area for waterfall placement.
3. Using a permanent marker, carefully draw a line where the edge of waterfall is to lay.
4. Mark template with an arrow showing direction of water flow. Write "top" on the template that represents the top of the waterfall unit.
5. Mail to: Attn: Custom Cascade Sales, 42306 Remington Ave., Temecula CA 92590.

If Your Waterfall Gets Warped From Heat/Sun Exposure:

1. Return waterfall to be exposed to heat/sun to soften plastic.
2. When unit is warm, remove from sun or heat source.
3. Immediately distribute weight across the top of the waterfall. A good method is to cover the top of the waterfall with cement blocks. Allow to cool overnight.
4. Once the waterfall is back in shape, cover and store in a cool place until ready to install.

Remember this is basic information, designed to be used as a guideline only. Your specific jobs may need adjustments.

CUSTOM CASCADE WATER FEATURE STYLE CHART

Products below may be available in ABS Plastic or Metal. Contact Customer Service for details.

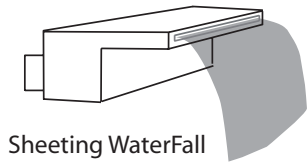

Sheeting WaterFall



Sheeting WaterFall
Radius

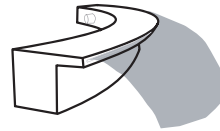

Sheeting WaterFall
Curved Vessel



Sheeting WaterFall
Compound Radius

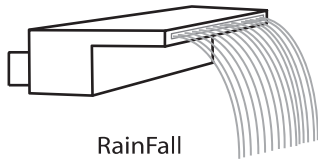

RainFall



RainFall Radius

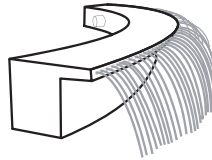

RainFall Curved Vessel



RainFall
Compound Radius

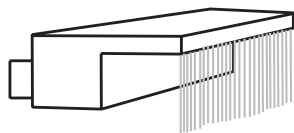

RainCurtain

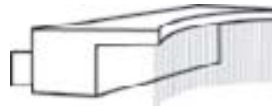

RainCurtain Radius

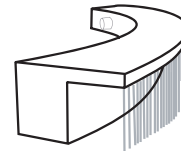

RainCurtain
Curved Vessel



RainCurtain
Compound Radius

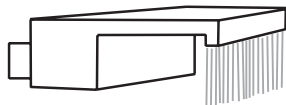

RainCurtain 90 Degree

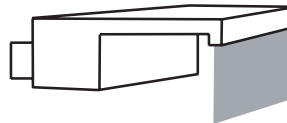

CurtainFall 90 Degree

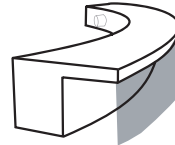

CurtainFall
Curved Vessel



CurtainFall
Compound Radius

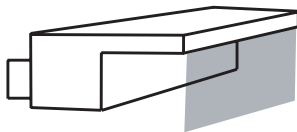

CurtainFall

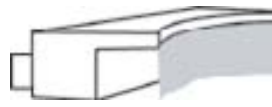

CurtainFall Radius



SpillWay



Radius SpillWay



Plastic ArcFall



Plastic ArcFall Vinyl

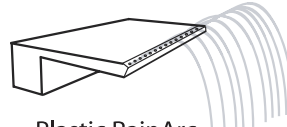

Plastic RainArc



Plastic RainArc Vinyl

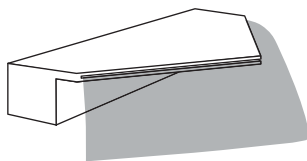

Sheeting Corner WaterFall

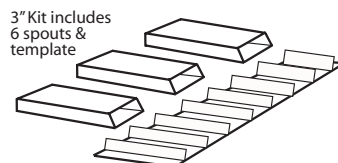

3" Kit includes
6 spouts &
template
TishWay 3"

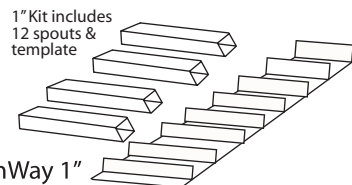

1" Kit includes
12 spouts &
template
TishWay 1"



Channel Spout

Continued on the next page.

Remember this is basic information, designed to be used as a guideline only. Your specific jobs may need adjustments.

CUSTOM CASCADE WATER FEATURE STYLE CHART

All products below are available in Stainless Steel, Copper or Brass,
contact customer service for details.



SpillWay



Radius SpillWay



Channel Spout

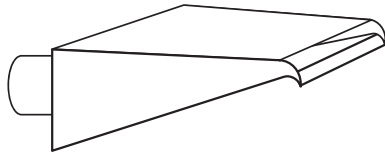

Scupper

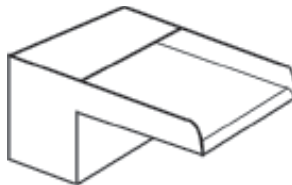

OpenTop Water Fall



Radius SpillEdge

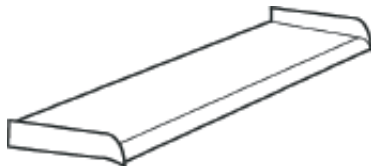

SpillEdge

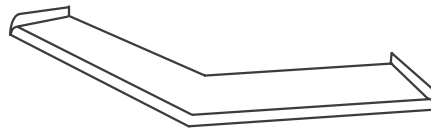

Corner SpillEdge

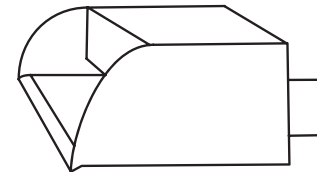

Step Scupper

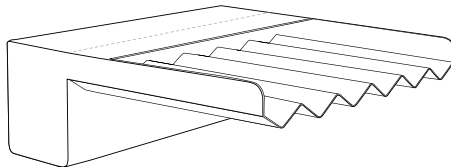

RiverFall

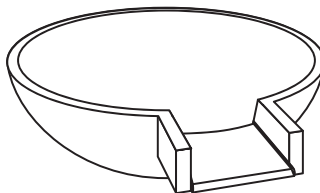

Round Urn
(Recommended SpillEdge)

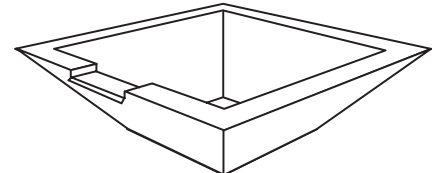

Square Pot

FLOATING FOUNTAIN & SPRAY CAPS

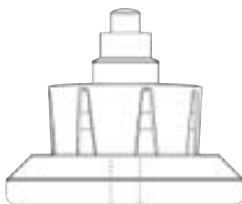

Floating Fountain - 3 Tier
Available with LED Lighting



PVC Spray Cap 3/4" Slip



PVC Spray Cap 3/4" Thread

Remember this is basic information, designed to be used as a guideline only. Your specific jobs may need adjustments.

PLASTIC RADIUS CASCADE FALL - LIP SIZING CHART

Waterfall Length

Radius Size	Waterfall Length									
	1'	1.5'	2'	3'	4'	5'	6'	7'	8'	
1'	6" Lip	12" Lip	n/a	n/a	n/a	n/a	n/a	n/a	n/a	n/a
1.5'	6" Lip	6" Lip	12" Lip	n/a	n/a	n/a	n/a	n/a	n/a	n/a
2'	6" Lip	6" Lip	6" Lip	12" Lip	n/a	n/a	n/a	n/a	n/a	n/a
2.5'	6" Lip	6" Lip	6" Lip	12" Lip	n/a	n/a	n/a	n/a	n/a	n/a
3'	6" Lip	6" Lip	6" Lip	12" Lip	12" Lip	n/a	n/a	n/a	n/a	n/a
3.5'	6" Lip	6" Lip	6" Lip	12" Lip	12" Lip	n/a	n/a	n/a	n/a	n/a
4'	6" Lip	6" Lip	6" Lip	6" Lip	12" Lip	n/a	n/a	n/a	n/a	n/a
4.5'	6" Lip	6" Lip	6" Lip	6" Lip	12" Lip	12" Lip	n/a	n/a	n/a	n/a
5'	6" Lip	6" Lip	6" Lip	6" Lip	12" Lip	12" Lip	n/a	n/a	n/a	n/a
5.5'	6" Lip	6" Lip	6" Lip	6" Lip	12" Lip	12" Lip	n/a	n/a	n/a	n/a
6'	6" Lip	6" Lip	6" Lip	6" Lip	12" Lip	12" Lip	12" Lip	n/a	n/a	n/a
6.5'	6" Lip	6" Lip	6" Lip	6" Lip	6" Lip	12" Lip	12" Lip	n/a	n/a	n/a
7'	6" Lip	6" Lip	6" Lip	6" Lip	6" Lip	12" Lip	12" Lip	n/a	n/a	n/a
7.5'	6" Lip	6" Lip	6" Lip	6" Lip	6" Lip	12" Lip	12" Lip	n/a	n/a	n/a
8'	6" Lip	6" Lip	6" Lip	6" Lip	6" Lip	12" Lip	12" Lip	12" Lip	n/a	n/a
8.5'	6" Lip	6" Lip	6" Lip	6" Lip	6" Lip	12" Lip	12" Lip	12" Lip	n/a	n/a
9'	6" Lip	6" Lip	6" Lip	6" Lip	6" Lip	12" Lip	12" Lip	12" Lip	n/a	n/a
9.5'	6" Lip	6" Lip	6" Lip	6" Lip	6" Lip	12" Lip	12" Lip	12" Lip	n/a	n/a
10'	6" Lip	6" Lip	6" Lip	6" Lip	6" Lip	6" Lip	12" Lip	12" Lip	12" Lip	n/a
10.5'	6" Lip	6" Lip	6" Lip	6" Lip	6" Lip	6" Lip	12" Lip	12" Lip	12" Lip	12" Lip
11'	6" Lip	6" Lip	6" Lip	6" Lip	6" Lip	6" Lip	12" Lip	12" Lip	12" Lip	12" Lip
11.5'	6" Lip	6" Lip	6" Lip	6" Lip	6" Lip	6" Lip	12" Lip	12" Lip	12" Lip	12" Lip
12'	6" Lip	6" Lip	6" Lip	6" Lip	6" Lip	6" Lip	12" Lip	12" Lip	12" Lip	12" Lip
12.5'	6" Lip	6" Lip	6" Lip	6" Lip	6" Lip	6" Lip	12" Lip	12" Lip	12" Lip	12" Lip
13'	6" Lip	6" Lip	6" Lip	6" Lip	6" Lip	6" Lip	12" Lip	12" Lip	12" Lip	12" Lip
13.5'	6" Lip	6" Lip	6" Lip	6" Lip	6" Lip	6" Lip	12" Lip	12" Lip	12" Lip	12" Lip
14'	6" Lip	6" Lip	6" Lip	6" Lip	6" Lip	6" Lip	6" Lip	12" Lip	12" Lip	12" Lip

Curved Vessel

METAL RADIUS CASCADE FALL - LIP SIZING CHART

Waterfall Length

Radius Size	Waterfall Length									
	1'	1.5'	2'	3'	4'	5'	6'	7'	8'	
1'	6" Lip	n/a	n/a	n/a	n/a	n/a	n/a	n/a	n/a	n/a
1.5'	6" Lip	6" Lip	n/a	n/a	n/a	n/a	n/a	n/a	n/a	n/a
2'	6" Lip	6" Lip	6" Lip	n/a	n/a	n/a	n/a	n/a	n/a	n/a
2.5'	6" Lip	6" Lip	6" Lip	n/a	n/a	n/a	n/a	n/a	n/a	n/a
3'	6" Lip	6" Lip	6" Lip	n/a	n/a	n/a	n/a	n/a	n/a	n/a
3.5'	6" Lip	6" Lip	6" Lip	n/a	n/a	n/a	n/a	n/a	n/a	n/a
4'	6" Lip	6" Lip	6" Lip	n/a	n/a	n/a	n/a	n/a	n/a	n/a
4.5'	6" Lip	6" Lip	6" Lip	n/a	n/a	n/a	n/a	n/a	n/a	n/a
5'	6" Lip	6" Lip	6" Lip	6" Lip	n/a	n/a	n/a	n/a	n/a	n/a
5.5'	6" Lip	6" Lip	6" Lip	6" Lip	n/a	n/a	n/a	n/a	n/a	n/a
6'	6" Lip	6" Lip	6" Lip	6" Lip	n/a	n/a	n/a	n/a	n/a	n/a
6.5'	6" Lip	6" Lip	6" Lip	6" Lip	6" Lip	n/a	n/a	n/a	n/a	n/a
7'	6" Lip	6" Lip	6" Lip	6" Lip	6" Lip	n/a	n/a	n/a	n/a	n/a
7.5'	6" Lip	6" Lip	6" Lip	6" Lip	6" Lip	n/a	n/a	n/a	n/a	n/a
8'	6" Lip	6" Lip	6" Lip	6" Lip	6" Lip	n/a	n/a	n/a	n/a	n/a
8.5'	6" Lip	6" Lip	6" Lip	6" Lip	6" Lip	n/a	n/a	n/a	n/a	n/a
9'	6" Lip	6" Lip	6" Lip	6" Lip	6" Lip	n/a	n/a	n/a	n/a	n/a
9.5'	6" Lip	6" Lip	6" Lip	6" Lip	6" Lip	n/a	n/a	n/a	n/a	n/a
10'	6" Lip	6" Lip	6" Lip	6" Lip	6" Lip	6" Lip	n/a	n/a	n/a	n/a
10.5'	6" Lip	6" Lip	6" Lip	6" Lip	6" Lip	6" Lip	n/a	n/a	n/a	n/a
11'	6" Lip	6" Lip	6" Lip	6" Lip	6" Lip	6" Lip	n/a	n/a	n/a	n/a
11.5'	6" Lip	6" Lip	6" Lip	6" Lip	6" Lip	6" Lip	n/a	n/a	n/a	n/a
12'	6" Lip	6" Lip	6" Lip	6" Lip	6" Lip	6" Lip	n/a	n/a	n/a	n/a
12.5'	6" Lip	6" Lip	6" Lip	6" Lip	6" Lip	6" Lip	n/a	n/a	n/a	n/a
13'	6" Lip	6" Lip	6" Lip	6" Lip	6" Lip	6" Lip	n/a	n/a	n/a	n/a
13.5'	6" Lip	6" Lip	6" Lip	6" Lip	6" Lip	6" Lip	n/a	n/a	n/a	n/a
14'	6" Lip	6" Lip	6" Lip	6" Lip	6" Lip	6" Lip	6" Lip	n/a	n/a	n/a

Curved Vessel

CUSTOM CASCADE SPECIFICATION GUIDE - PLASTIC

Specs provided are for "standard" units and may vary slightly. Custom orders are always welcome.

Sheeting WaterFall

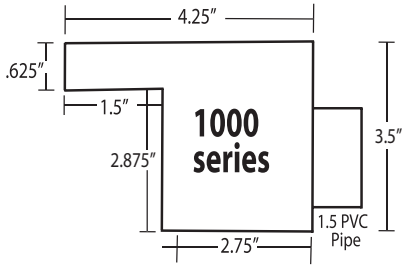

RainFall

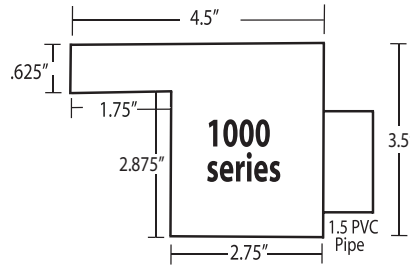

CurtainFall 90, RainCurtain 90°

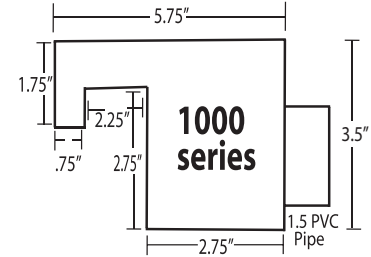

Sheeting WaterFall & RainFall

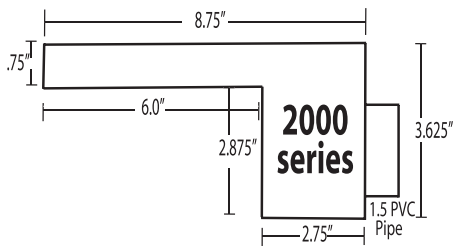

RainCurtain, CurtainFall

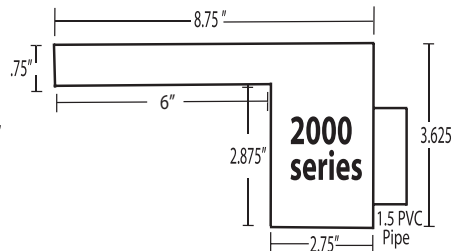

CurtainFall 90, RainCurtain 90°

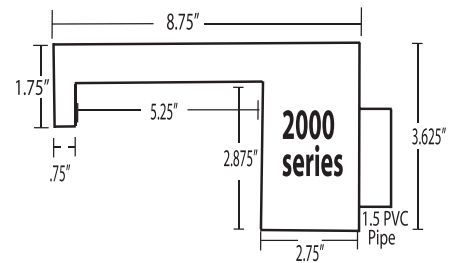

Sheeting WaterFall & RainFall

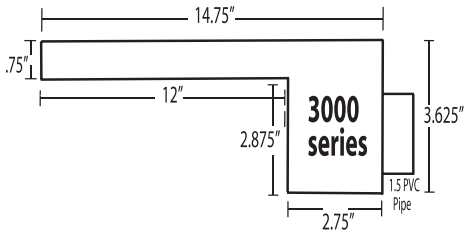

RainCurtain, CurtainFall

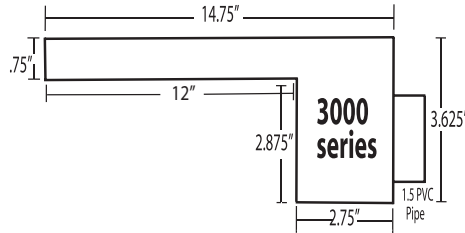

CurtainFall 90, RainCurtain 90°

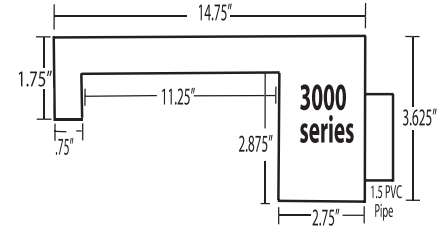

ArcFall

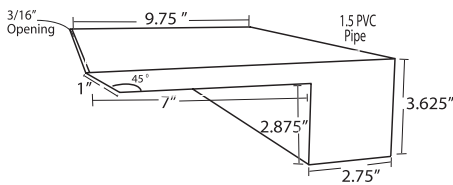

RainArc

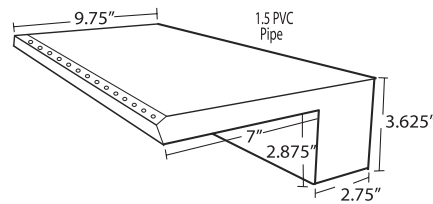

ArcFall/RainArc Vinyl Application

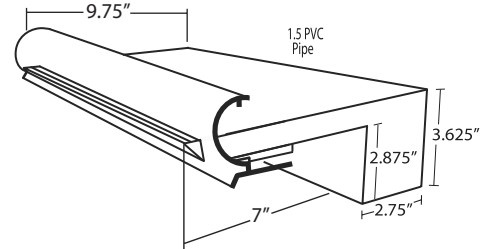

Channel Spouts

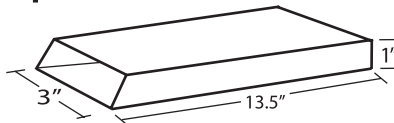
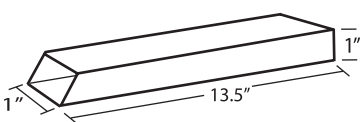

Decorative Colors

White, Tan, Gray, Black

Opening Specs:

1000 Series Waterfall - 1/8"

2000 & 3000 Series Waterfalls - 1/4"

RainFalls, RainCurtain, RainCurtain 90°
RainArc* hole pattern

1" Spacing	• • • • •
1/2" Spacing	• • • • •
* 1/2" Spacing Offset	• • • • •

*Not available for RainArc

Holes are 5/32" D
Set back 3/8" from
front of lip.

CUSTOM CASCADE SPECIFICATION GUIDE - METAL

Specs provided are for "standard" units and may vary slightly. Custom orders are always welcome.

Sheeting WaterFall

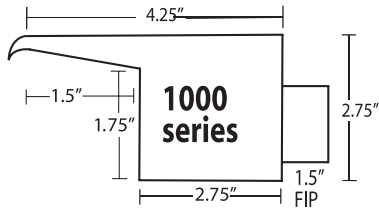

RainFall

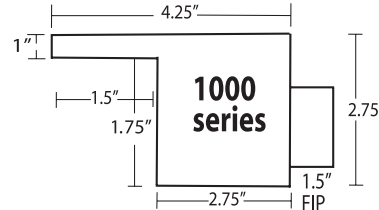

RainFalls, RainCurtain, RainCurtain 90°

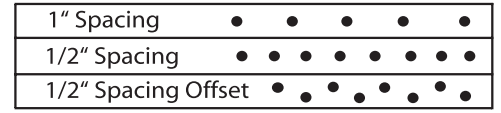

holes are 3/16"

Sheeting WaterFall

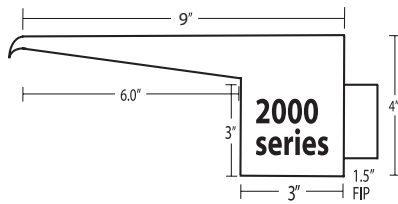

RainFall, CurtainFall, RainCurtain

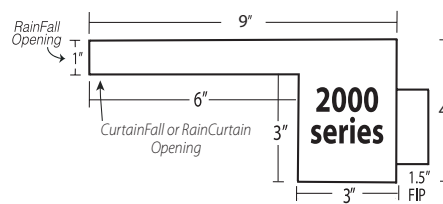

CurtainFall 90°, RainCurtain 90°

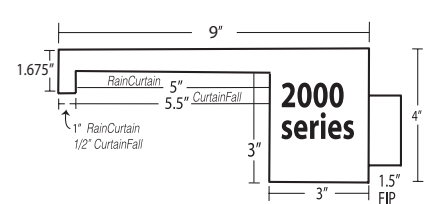

Sheeting WaterFall

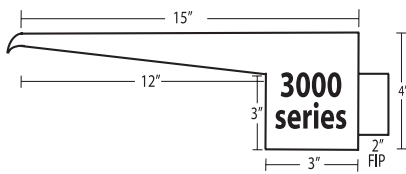

RainFall, CurtainFall, RainCurtain

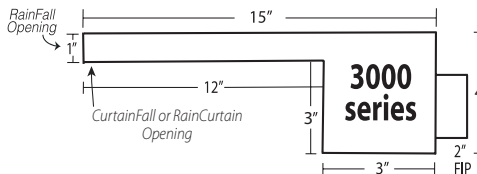

CurtainFall 90°, RainCurtain 90°

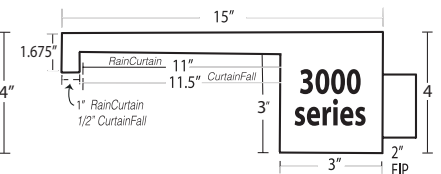

OpenTop WaterFall

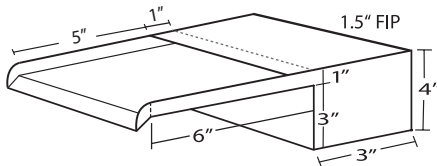

Spill Edge

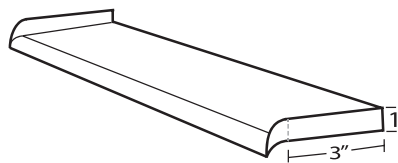

SpillWay

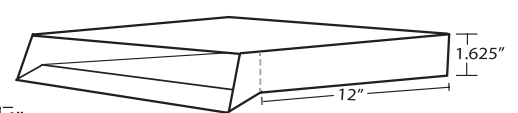

Step Scupper

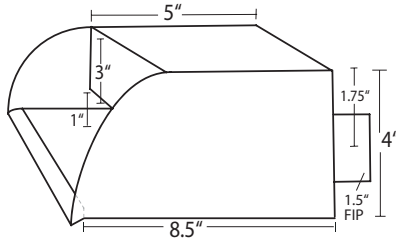

Scupper

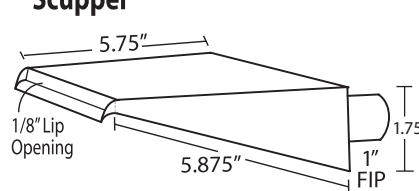

Channel Spouts

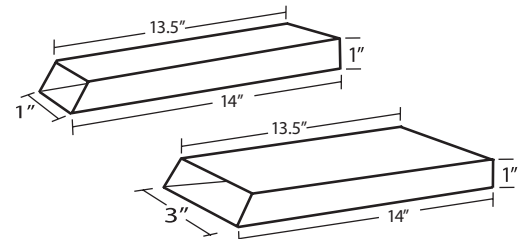

RiverFall

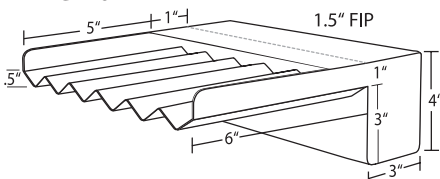

Material Specs:

Stainless Steel - .078"

Brass & Copper - .096"

2000 and 3000 Metal Box

Dimensions are 3" x 4".

Opening Specs:

1000 Series Waterfall - 1/8"

2000 & 3000 Series Waterfalls - 1/4"

No Drip Lips - 30° 5/8" over-hang

REGAL ACCENTS SPECIFICATION GUIDE

Specs provided are for "standard" units and may vary slightly. Custom orders are always welcome.

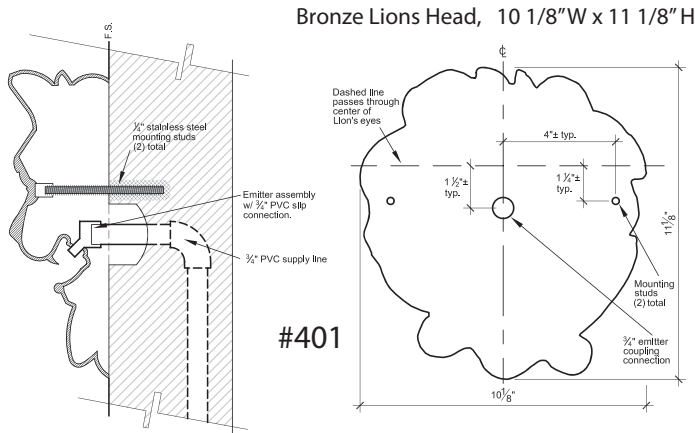
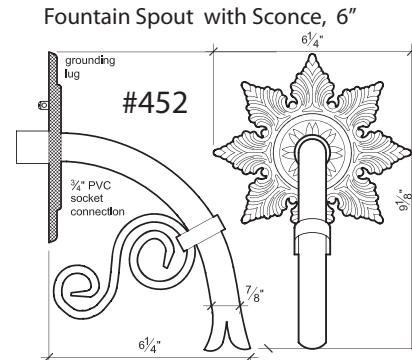
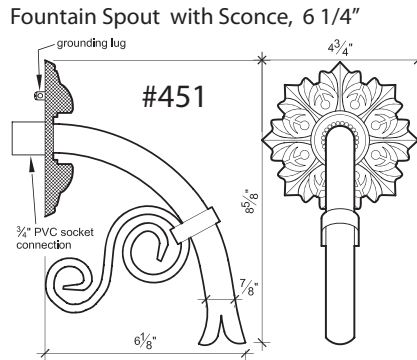
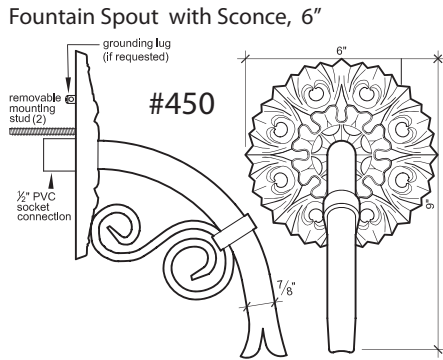
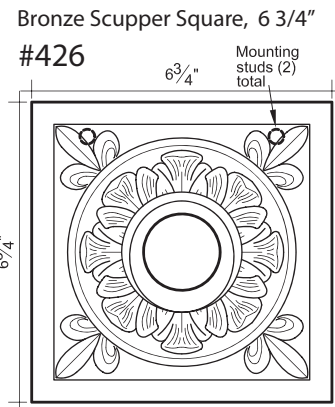
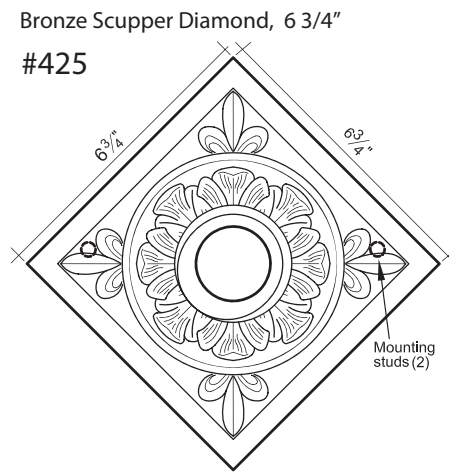
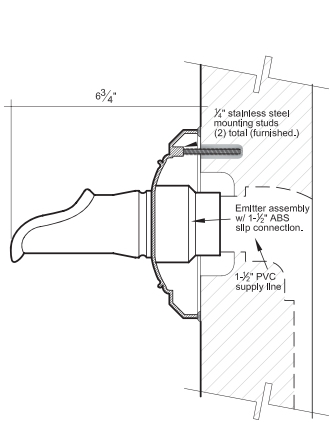
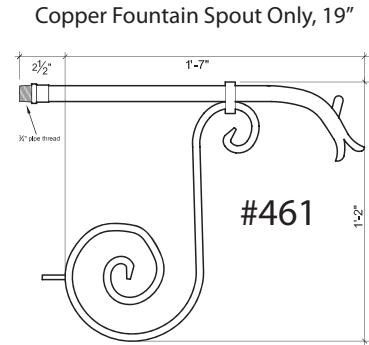
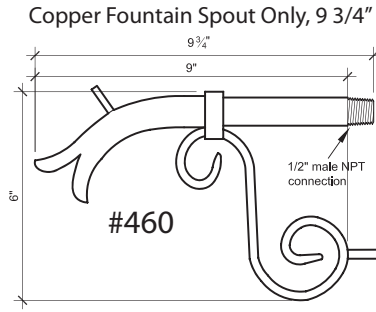
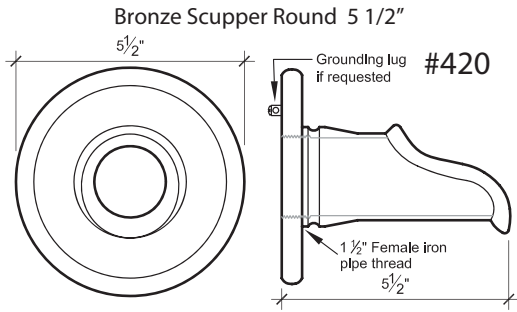

CUSTOM CASCADE FLOW CHARTS

1000, 2000, and 3000 Sheeting WaterFall Series

Recommended gallons per minute: 1000 Series - 10gpm, 2000 Series - 20gpm, 3000 Series - 30gpm.

Metal Series

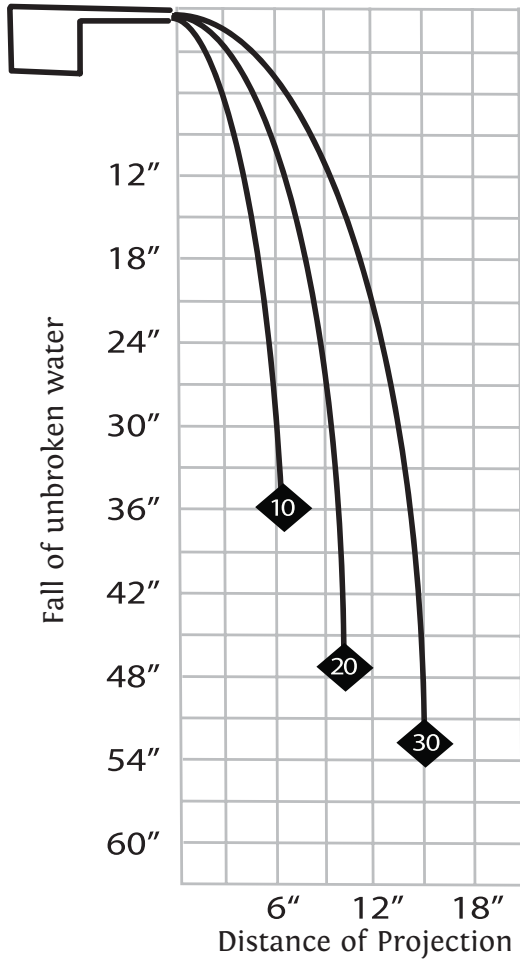

Plastic Series

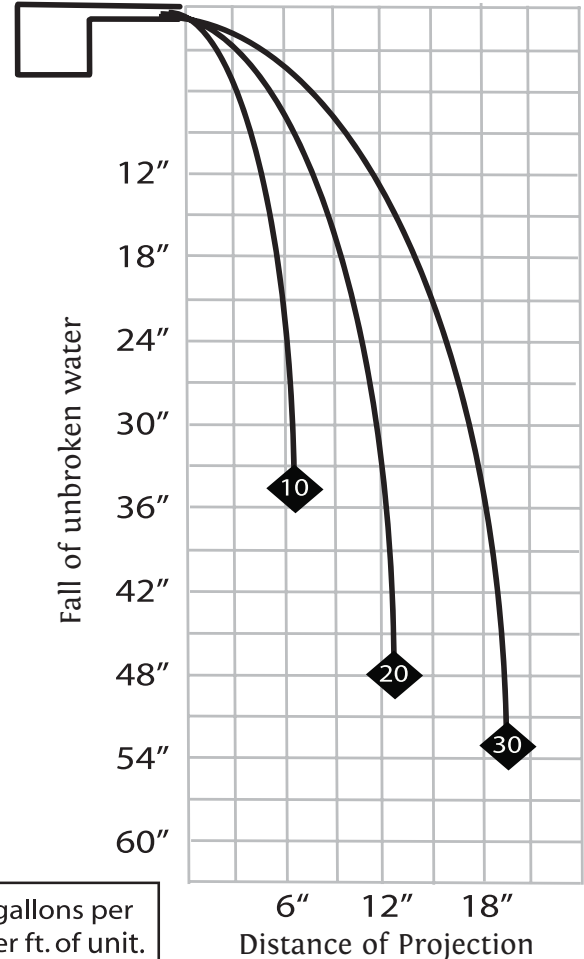

◆ GPM gallons per minute per ft. of unit.

These flow charts reflect approximate sheeting and projections of water based on gallons per minute (GPM) per foot of waterfall length. Water flow will vary with weather conditions, project design and overall hydraulics.

ArcFall Series

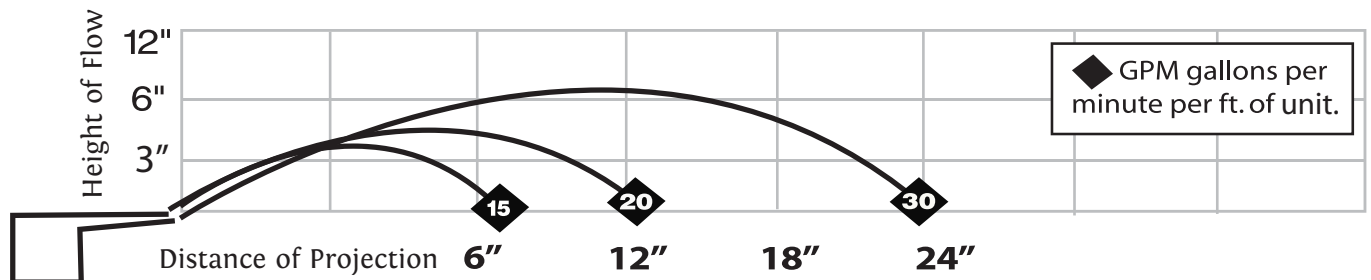

◆ GPM gallons per minute per ft. of unit.

CUSTOM CASCADE FLOW CHARTS

1000, 2000, and 3000 RainFalls or CurtainFalls - Plastic or Metal

RainFall Series

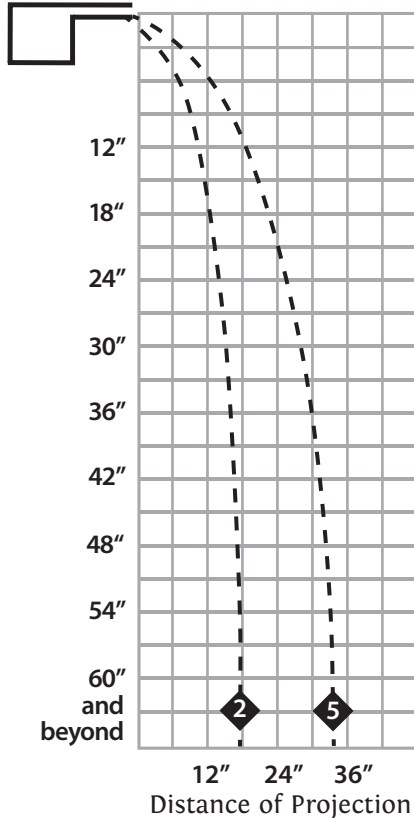

*RainCurtain Series

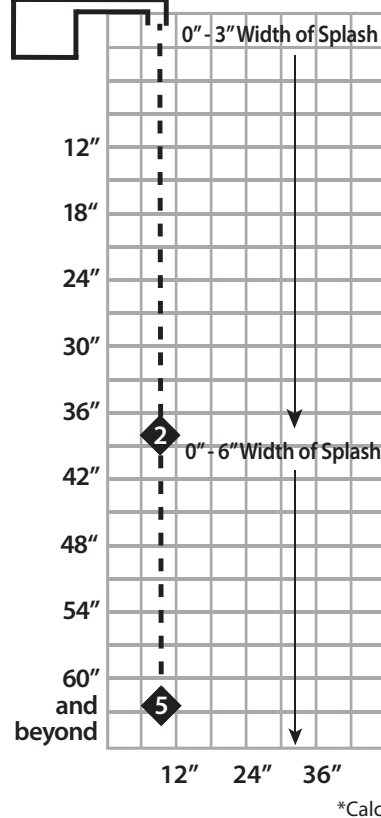

*CurtainFall Series

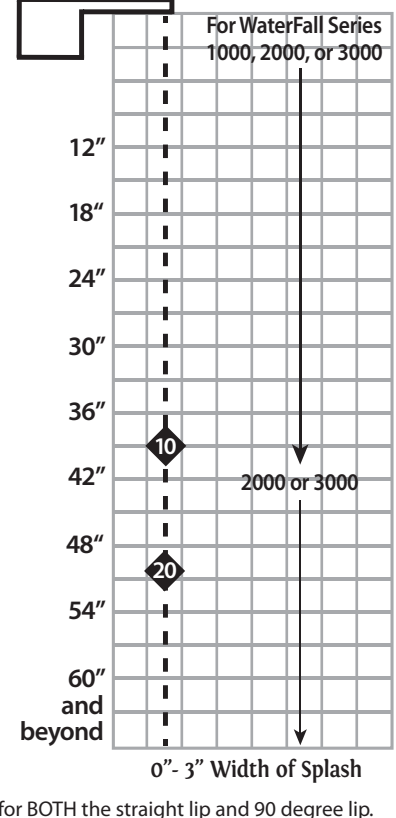

*Calculations for BOTH the straight lip and 90 degree lip.

These flow charts reflect approximate sheeting and projections of water based on gallons per minute (GPM) per foot of waterfall length. Water flow will vary with weather conditions, project design and overall hydraulics.

RainArc Series

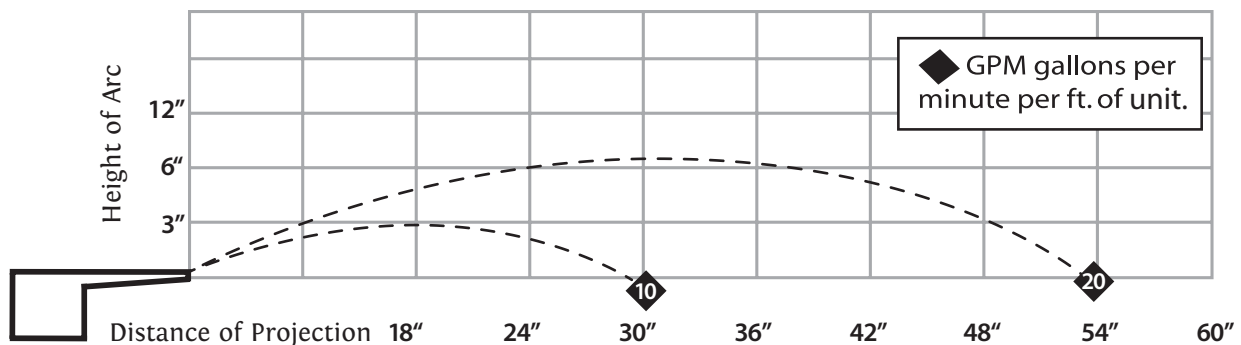

CUSTOM CASCADE FLOW CHARTS

Step Scupper & Standard Scupper

Available Metal Only

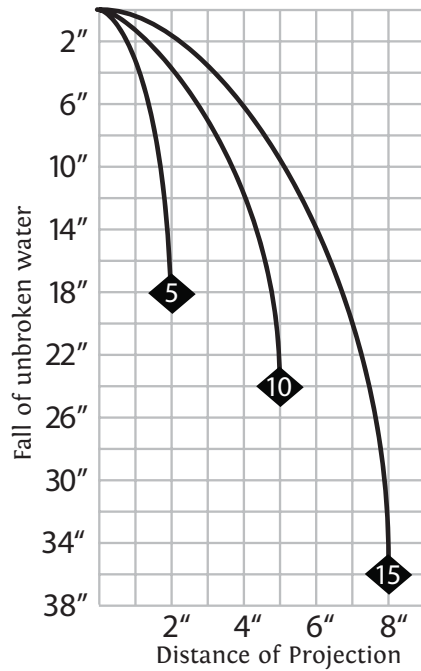

3" Channel Spout

Available Metal & ABS

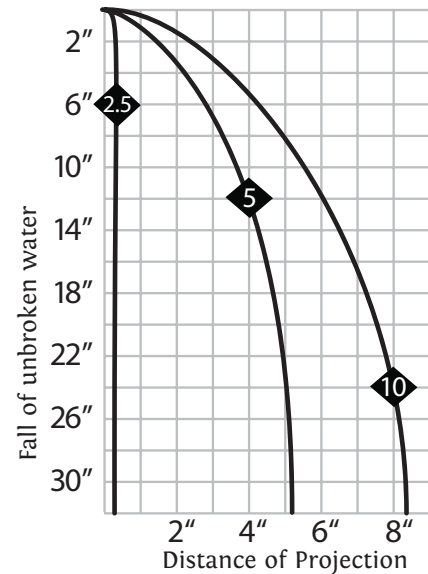

◆ GPM gallons per minute per ft. of unit.

These flow charts reflect approximate sheeting and projections of water based on gallons per minute (GPM) per foot of waterfall length. Water flow will vary with weather conditions, variance of water pressure and overall hydraulics.

Open Top Waterfall

Available Metal Only

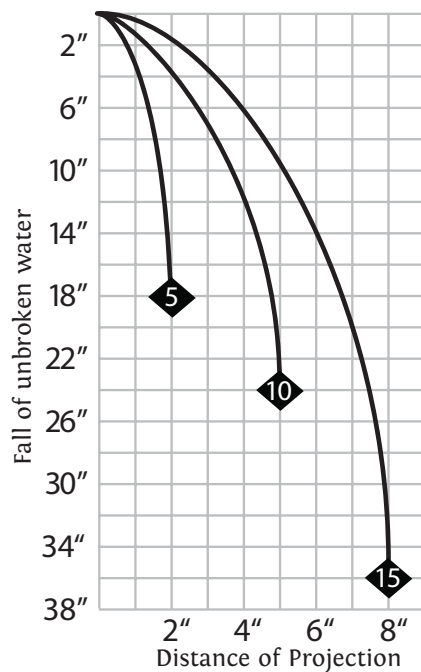

12" Spill Edge

Available Metal Only

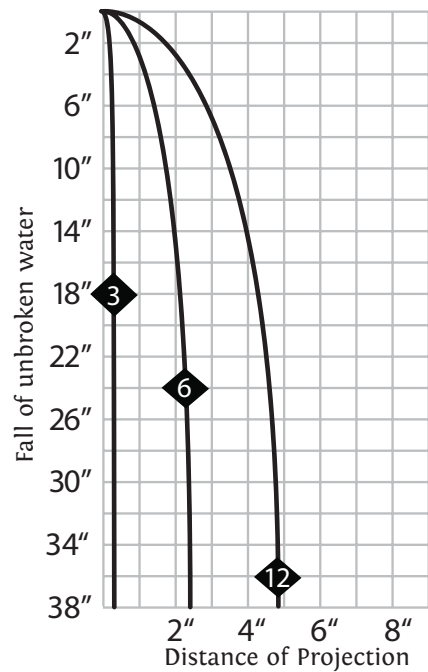

ABS PLASTIC WATER FEATURE INLET SPACING CHART

Back Inlet - 1.5" PVC Pipe (standard)
1000 Series - 1.5" Lip, 1/8" opening
2000 Series - 6" Lip, 1/4" opening
3000 Series - 12" Lip, 1/4" opening

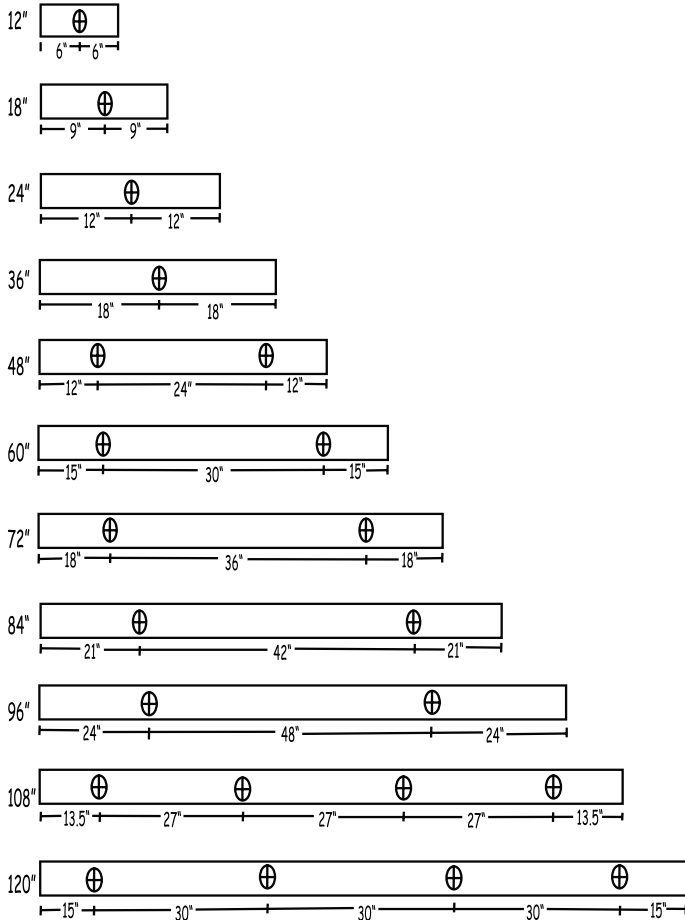

Bottom Inlet - 1.5" PVC Pipe (standard)
1000 Series - 1.5" Lip, 1/8" opening
2000 Series - 6" Lip, 1/4" opening
3000 Series - 12" Lip, 1/4" opening

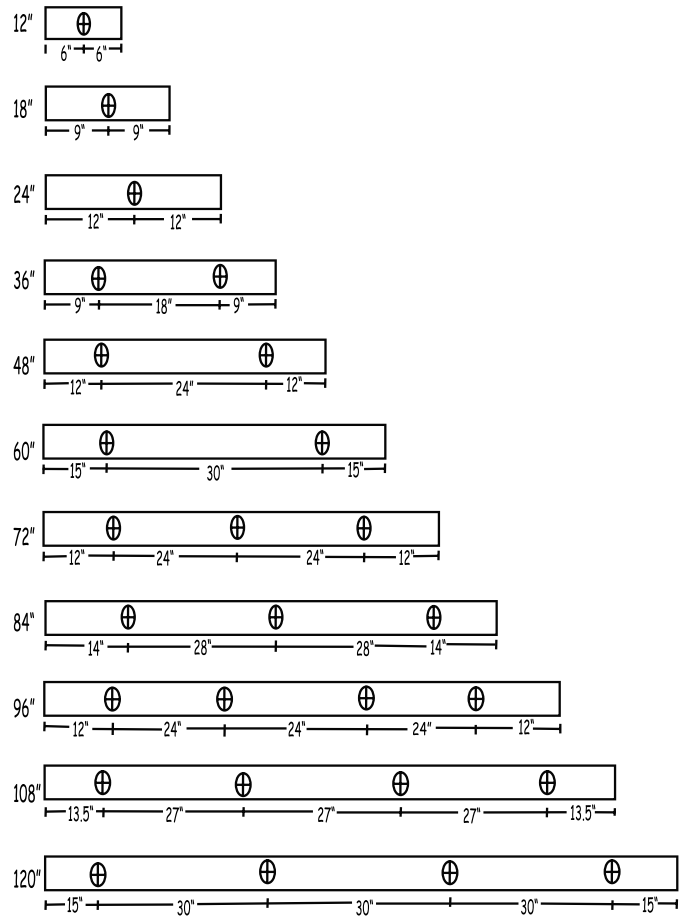

ArcFall & RainArc

Back or Bottom Inlet - 1.5" PVC Pipe (standard)

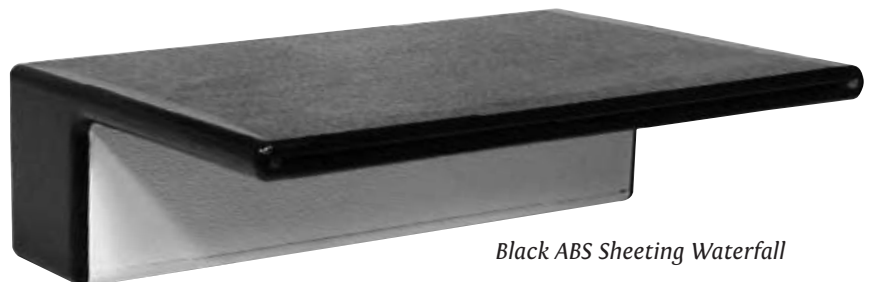
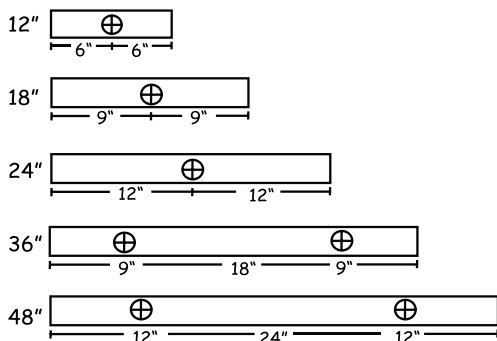

Black ABS Sheeting Waterfall

METAL CASCADE WATERFALLS INLET SPACING CHART

1000 Series - 1.5" Lip, 1/8" Opening, Back or Bottom Inlet 1.5" F.I.P. (back is standard)

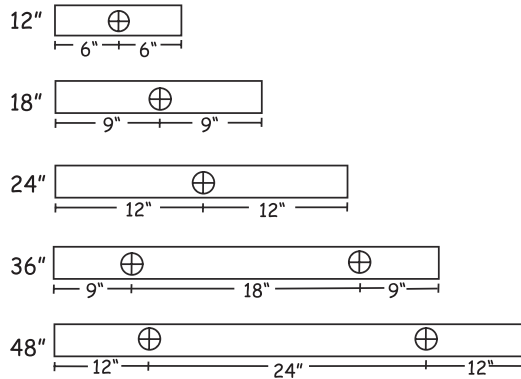

2000 Series - 6" Lip, 1/4" Opening, Back or Bottom Inlet 1.5" F.I.P. (back is standard)

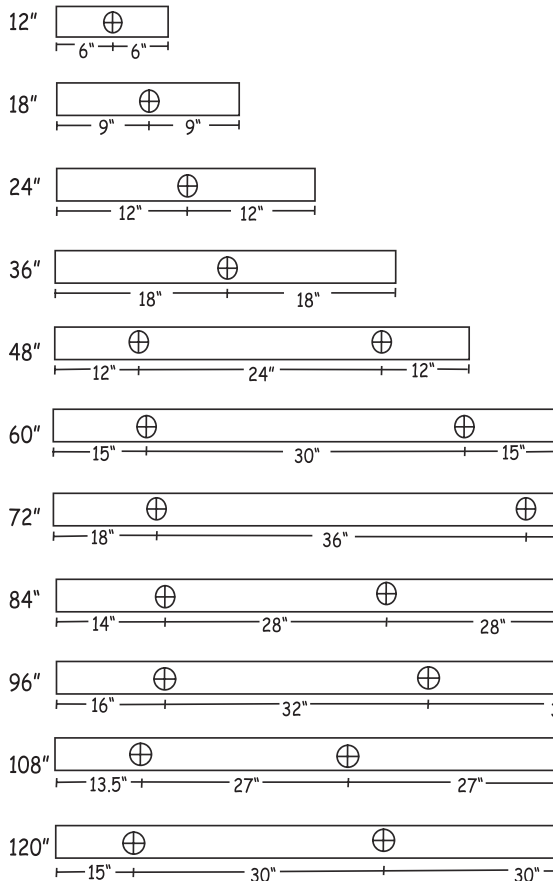

Metal Sheetting Waterfall

3000 Series Metal Inlets are 2" F.I.P.

Single-centered inlet up to 2'. All other sizes up to 10' use 12" from each end, then 2' on center.

SPILL EDGE INSTALLATION

READ ENTIRE INSTRUCTIONS FIRST!

The following instructions will help you make a trouble free installation of the Custom Cascades Spill Edge. Installation must be made according to manufacturer's recommendations for warranty to be valid. If you need assistance during installation you may call Oreq Corporation toll free at 1.800.420.3255

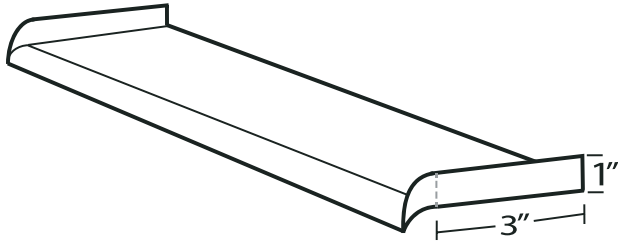

A Spill Edge is designed to facilitate the flow from a raised body of water to a lower body of water. An ideal application is from a raised spa to a swimming pool below. It can be used in place of the leading edge of tile or may be custom made to virtually any desired specifications.

STEP 1. PREPARE THE BEAM

Select the desired location for installation. Make sure the surface is clean and free of debris. Check that the Spill Edge is sized correctly for the location and that it fits properly in place. If the unit is made on a radius be sure that the gunite follows the correct curvature. Ensure that the ground wire is long enough to reach the bonding lug provided.

STEP 2. SETTING THE SPILL EDGE IN PLACE

Attach the ground wire to the spill edge. Apply a layer of thin set tile mortar about 1/4" thick to the leading edge of the bond beam. Place the flat area of the Spill Edge down into the thin set mortar, leaving the "No Drip Lip" hanging past finish. The wire mesh on the bottom of the Spill Edge should be encased in the thin set mortar. Level the Spill Edge.

When more than one Spill Edge is installed it is important that they all be at the same elevation to ensure an even flow over each.

***BE SURE THAT THE LIP IN FRONT OF THE SPILL EDGE IS MOUNTED TO BE PAST PLANNED FINISH. THE SHEET OF WATER WILL NOT BREAK OVER THE SPILL EDGE IF THE LIP IS TOO FAR BACK.**

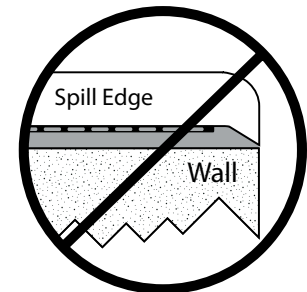
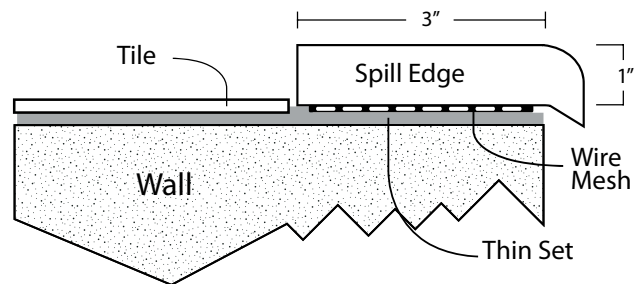

STEP 3. FINISHING

Install tile up to Spill Edge allowing for a grout joint. When plastering pool, double check to make sure Spill Edge is covered so that no plaster will get on the surface of the metal.

To clean Spill Edges with a brush finish a 3M Scotch Brite pad may be used in long even strokes, going with the grain of the metal. This process will expose the fresh metal, oxidizing of brass and copper spill edges is to be expected. Adjust the water flow valve(s) for desired effect.

WARRANTY:

It is Oreq's policy to replace or credit our customer for defective parts returned due to workmanship or material failure during the first year of sale. Prior factory approval is required for returns, along with original receipt. Failure to follow manufacture recommended instructions for installation and or care voids all warranty. Oreq Corporation is not responsible for cost of removal of product, or installation of replacement unit. Oreq is not responsible for shipping to or from facility, or damage done by shipper.

WARNING: Improper chemical balance of pool water may cause corrosive conditions for metal water features. Oreq will not warranty products exposed to such water conditions or salt chlorine generators.

ARCFALL/RAINARC INSTALLATION: GUNITE APPLICATION

READ ENTIRE INSTRUCTIONS FIRST!

The following instructions will help you make a trouble free installation of the Custom Cascades ArcFall or RainArc. Installation must be made according to manufactures recommendations for warranty to be valid. If you need assistance during installation you may call Oreq at 800.420.3255

Before you begin, KNOW the appropriate GPM requirements for your specific water feature. Calculate in head loss, pump sizing and plumbing to meet these requirements. Remember more water, valved is better than not enough.

STEP 1. NOTCHING THE BOND BEAM

- Select the desired location for installation. Bend steel reinforcement to allow for installation of the ArcFall/RainArc manifold.
- Notch the bond beam or wall low enough to allow the face of the ArcFall/RainArc (the front opening) to finish 1/2" more than the entire overhang of the coping. For example, if coping material cantilevers out 2" the ArcFall/RainArc needs to be 2 1/2" below the bottom of the coping.
- Leave enough room at face of ArcFall/RainArc for any finishing materials, plus an extended 1/4" at top of ArcFall/RainArc opening.

STEP 2. PLUMBING

Plumbing line must be blown clean of debris BEFORE attaching water feature. Water supply to manifold MUST be filtered between pump and water feature.

- Connect a length of standard one and one half inch (1 1/2") schedule 40 PVC piping approximately twelve (12") inches long (to extend in back of pool wall) and glue into PVC male adapter on the back of the waterfall manifold.
- Plumbing multiple units: Plumbing two or more units together is done using a two-way valve for each waterfall unit to be installed. The use of multiple valves allows the flow rate to be balanced for each unit. Valves should be positioned near the
- FREEZE PROTECTION** can be achieved by plumbing the unit so water drains easily from the system. For winterizing, blow lines and follow normal procedure.

STEP 3. SETTING ARCFALL/RAINARC MANIFOLD

- Set manifold in place with mortar, **MORTAR BACK AND BOTTOM ONLY. IMPORTANT:** Adjust front of lip to desired position of finished wall inside pool. Be sure to leave adequate overhang to accommodate 1/4" overhang beyond finished wall.
- Level ArcFall/RainArc manifold.
- To help secure the waterfall in position until concrete is dry, cover finished setting with one half (1/2") inch or three quarters (3/4") inch plywood. Place bricks or a cinder block on top of the plywood to distribute weight evenly over the waterfall manifold and the bond beam.

STEP 4. FINISHING

- Remove protective plywood cover and install mortar, coping (brick, etc). Take caution to keep all concrete away from ArcFall lip area. Be sure the finished wall surface is 1/4" behind waterfall lip edge.
- Once concrete has cured you may remove the masking tape from the ArcFall lip. After start up, you may use a credit card or similar item to clean debris that may have fallen into ArcFall lip. Gently slide card along the opening while the Arc Fall is running. Do not use sharp objects such as hacksaw blade, knife etc. Sharp objects may cause damage to the lip and or support ribs inside the unit and affect the ArcFalls performance. Gently pull any debris in the lip opening area out.
- Adjust the valve(s) for desired effect. When more than one ArcFall has been installed, adjust each valve until proper effect and balance are accomplished.

WARRANTY:

It is Oreq policy to replace or credit our customer for defective parts returned due to workmanship or material failure during the first year of sale. Prior factory approval is required for returns, along with original receipt. Failure to follow manufacture recommended instructions for installation and or care voids all warranty. Oreq Corporation is not responsible for cost of removal of product, or installation of replacement unit. Oreq is not responsible for shipping to or from facility, or damage done by shipper.

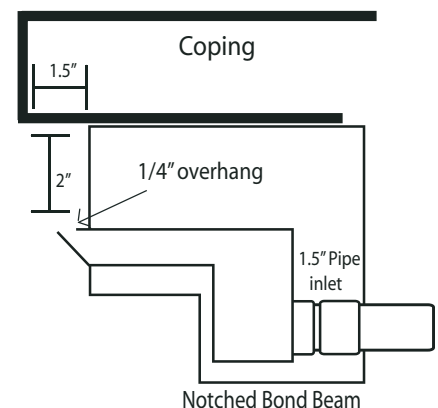

ARC FALL/RAIN ARC INSTALLATION: VINYL APPLICATION

READ ENTIRE INSTRUCTIONS FIRST!

The following instructions will help you make a trouble-free installation of the Custom Cascades Waterfall. Installation must be made according to manufacturer's recommendations for warranty to be valid. Care guide is provided to give guidelines for maintenance of the waterfall.

Vinyl Arc Falls/RainArc Units designed for Deck Form applications are sold as a kit that includes:

- (A) Unit with attached mounting plate
- (B) Pre-Cut, custom fit, deck form section
- (C) OR pre-cut CP2 coping

Hardware -self tapping screws (not shown)

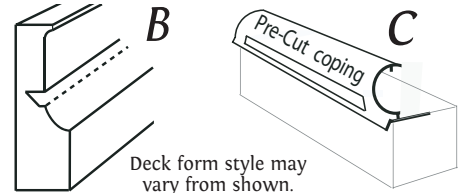
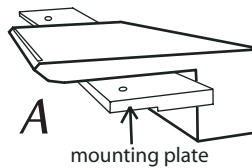

Deck form style may vary from shown.

STEP 1. MOUNTING ARCFALL AND FORM

NOTE : When setting forms, always attach liner track according to deck form manufactures instructions before proceeding it is recommended that you set the water feature wall form section(s) first.

- A. Secure provided, pre-notched deck form in desired waterfall location.
- B. Cover lip opening with low residue masking tape to keep any debris from entering unit during construction. Protect the entire area, including plumbing, from bearing any type of heavy weight or debris getting trapped inside.

Deck Form Applications

- C. Set, but do NOT secure unit mounting plate on wall in desired location. Mounting plate is step-cut to fit flat against liner track. Unit will set 1.5" beyond the pool wall.
- D. Securely place the notched deck form over the extended portion of unit lip. Remove attachment tape from deck form. Snap the tabs into liner track per deck form manufactures instructions.

For CP2 Applications

- C. Attach pre-cut CP2 coping to pool wall.
- D. Insert the water feature unit through the opening of coping. The opening of the unit MUST be entirely exposed through the pre-cut opening to prevent blockage of flow. Mounting plate is step-cut to fit flat against liner track.

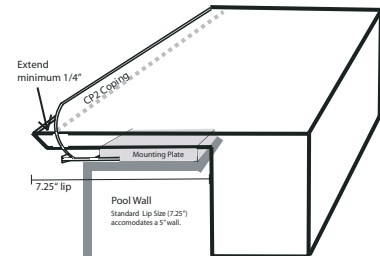
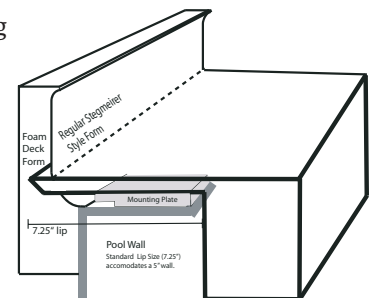

- E. Using the pre-drilled holes on the mounting plate, secure unit to wall with the self tapping screws provided.
- F. Attach remaining deck forms per manufactures instructions. It is recommended that you finish with the two deck forms that will attach to either side of the waterfall section.

STEP 2. PLUMBING

Plumbing line must be blown clean of debris BEFORE attaching water feature.

Water supply to manifold MUST be filtered between pump and water feature.

- A. Connect a length of standard one and one half inc (1 1/2") schedule 40 PVC piping approximately twelve (12") inches long (to extend in back of pool wall) and glue into PVC male adapter on the back of the waterfall manifold.
- B. **PLUMBING MULTIPLE UNITS:** Plumbing two or more units together is done using a two way valve for each waterfall unit to be installed. The use of multiple valves allows the flow rate to be balanced for each unit. Valves should be positioned near the water feature in a standard covered deck box for easy accessibility.
- C. **FREEZE PROTECTION** can be achieved by plumbing the unit so water drains easily from the system. For winterizing, blow lines and follow normal procedure.

STEP 3. FINISHING

- A. Finish concrete deck per manufacturers' instructions, including removal of forms. Use trowel provided by form manufacturer to finish coping edge. Take caution to keep all concrete away from units lip area.
- B. Once concrete has cured you may remove the masking tape from the unit lip. After start up, you may use a credit card or similar item to clean debris that may have fallen into units lip. Gently slide card along the opening while the unit is running. Do not use sharp objects such as hacksaw blade, knife etc. Sharp objects may cause damage to the lip and or support ribs inside the unit and affect the units performance. Gently pull any debris in the lip opening area out.
- C. Adjust the valve(s) for desired effect. When more than one unit has been installed, adjust each valve until proper effect and balance are accomplished.

WATERFALL INSTALLATION FOR PLASTIC AND METAL WATERFALL MANIFOLDS

READ ENTIRE INSTRUCTIONS FIRST!

The following instructions will help you make a trouble-free installation of the Custom Cascades Waterfall. Installation must be made according to manufacturer's recommendations for warranty to be valid. Care guide is provided to give guidelines for maintenance of the waterfall.

IMPORTANT! PLASTIC Falls should be kept from direct sunlight!

Do not remove protective grout guard from PLASTIC Falls until installation is complete. For metal falls, cover lip with masking tape.

Before you begin - KNOW the appropriate GPM requirements for your specific water feature. Calculate in head loss, pump sizing and plumbing to meet the se requirements. Remember, more water with a valve is better than not enough.

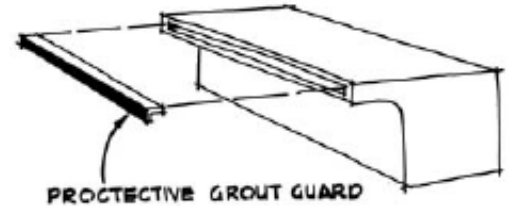

STEP 1. NOTCHING THE BOND BEAM

A. Select the desired location for installation. Bend steel reinforcement to allow for installation of the waterfall manifold.

B. Mark a channel for the plumbing to the waterfall: Before concrete hardens, a notch must be cut into the bond beam where the steel reinforcement has been offset to clear bottom of manifold.

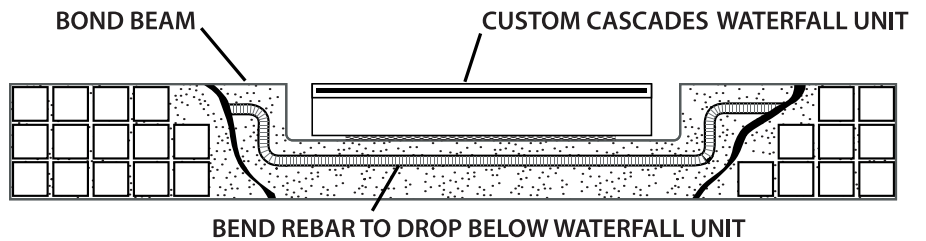

First, mark the notch in the front side of the bond beam to be cut 3 3/4" deep. Cut the notch for the manifold 2" longer than the length of the waterfall to be installed and allow a maximum of 5" in the notch for the manifold and lip. Complete concrete work.

1. For standard water fall manifolds with a single PVC connection on the back: Mark and cut one slot in the center of the bond beam 3 3/4" deep and 2 1/2" wide extending through the entire bond beam.

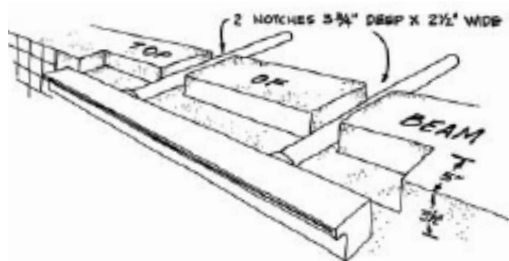
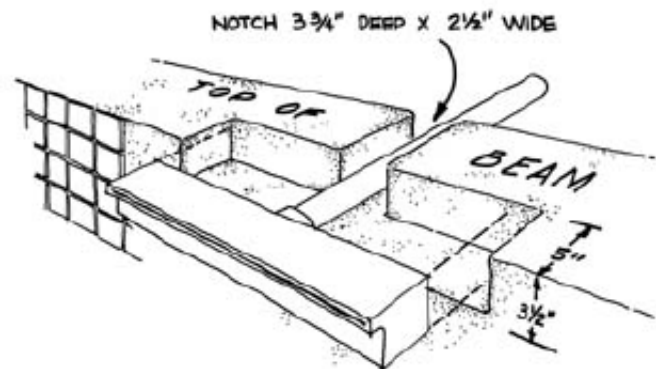

2. For standard waterfall manifolds with two or more connections on the back: Hold manifold in position over the bond beam and mark location of each inlet. Cut slots to size as described above.

Installation for extended or radius cut waterfall manifolds is simpler than single or double inlets. Mark notch for the manifold on the backside of the bond beam and follow the same directions as (1) and (2), above.

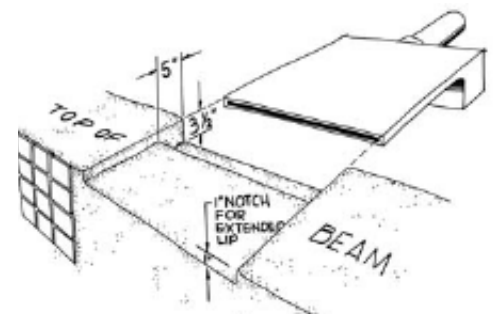

Cutting the lip for radius installation of plastic extended lip waterfall.

(Refer to Page 6 for additional tips and techniques.)

The plastic extended lip manifold can be cut to form convex or concave curves. To custom fit your waterfall, determine the amount of the extended lip you wish to remove and mark with pencil. Remember to leave enough lip to allow for mortar and tile. When cutting a radius the remaining lip must **not** be less than 1.5" in length from the body of the fall at any point.

Before cutting the waterfall, remove the protective tongue from the lip. Cut the extended lip with a coarse tooth sabre saw. Make your cut as smoothly and quickly as possible to avoid a rough edge and melting. After completing the cut, grab the rib sections with rib tool provided with waterfall and by carefully rocking from side to side break off 1/2" to 1" of rib sections. This will allow the water to rejoin into a sheet. Remove the loose rib sections from the waterfall lip. Smooth the surface with a sanding block and a coarse grade of sandpaper, then finish with a fine grade sandpaper. Replace the protective grout guard into the lip.

WARNING!

Radius cuts other than those manufactured by Custom Cascades will void any and all product warranties. Custom Cascades does not recommend that user cut radius or any other such cut. Custom Cascades has available both concave and convex radius cuts. For further information on waterfall customizing, contact Custom Cascades.

STEP 2. SETTING WATERFALL MANIFOLD IN PLACE

- Connect a 1 1/2" coupling and a length of standard 1.2" schedule 40 PVC piping approximately twelve (12") inches long (to extend beyond back of bond beam) and glue into slip joint inlet on the back of the waterfall manifold. This will allow you to complete mortar set now and complete plumbing later.
- Set manifold in place with mortar, **MORTAR BACK AND BOTTOM ONLY**.
IMPORTANT: Adjust front of lip to desired position of finished wall inside pool.
- Level waterfall manifold.
- To help secure the waterfall in position until concrete is dry, cover finished setting with one-half (1/2") inch or three-quarters (3/4") inch plywood. Place bricks or a cinder block on top of the plywood to distribute weight evenly over the waterfall manifold and the bond beam. Keep the waterfall covered to protect it from heat or direct sun light as this may warp the PLASTIC.

***IMPORTANT:** This procedure must always be followed when installing all waterfalls.

Stainless Steel Manifold Placement

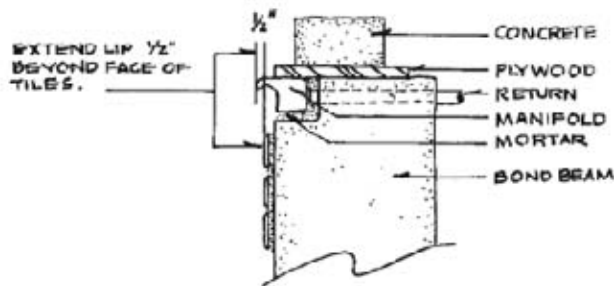

1000 Series PLASTIC Manifold Placement

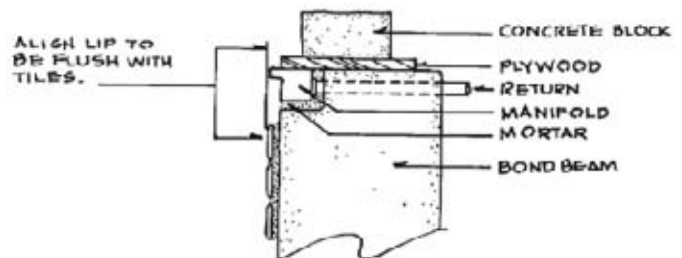

Extended Lip PLASTIC Manifold Placement

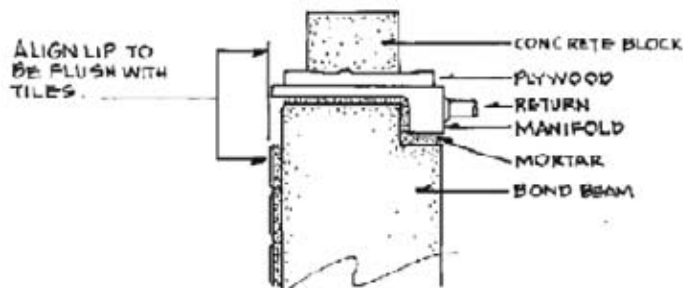

STEP 3. PLUMBING

Plumbing Multiple Units – Plumbing two or more units together is done using the same procedure as for a single unit waterfall. The exception is the addition of a two-way valve for each waterfall unit to be installed. The use of multiple valves allows the flow rate to be balanced for each unit. Valves should be positioned near the bond beam in a standard covered deck box for easy accessibility. When installing two or more units, it is recommended that the same models are used.

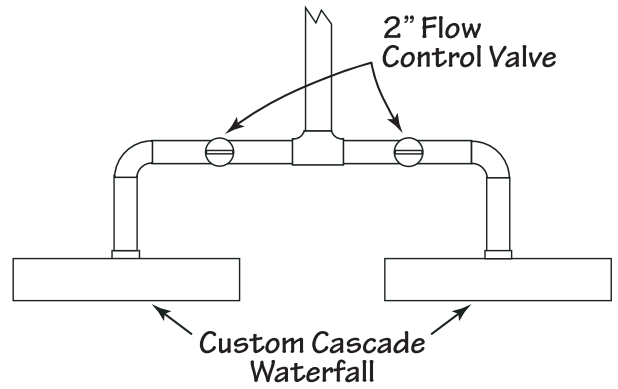
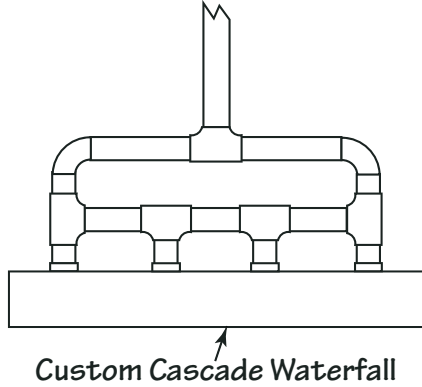

Plumbing with 3 or more inlets is done by using a loop configuration. FREEZE PROTECTION can be achieved by plumbing the unit so water drains easily from the system. For winterizing, blow lines and follow normal procedure. Plumbing line must be blown clean of debris BEFORE attaching water feature. Water supply to manifold MUST be filtered between pump and water feature.

STEP 4. FINISHING

Install coping – remove protective plywood cover and install mortar, coping (brick, etc.). When plastering pool, double check to make sure protective grout guard is in place so that no plaster will get inside the waterfall lip. After all concrete, plaster and grout work are completed you may remove the protective lip guard from the lip of the manifold.

Be sure no debris is lodged in the opening of the waterfall. To clean the opening, use a credit card or similar object and gently slide along the opening while the waterfall is on. Do not use sharp edged objects (i.e., hacksaw blades, knives, etc.). The misuse of such objects can affect the waterfall performance. When you reach the obstruction, gently pull it outward through the opening.

Adjust the valve(s) for desired effect. When more than one waterfall has been installed, adjust each valve until proper effect and balance are accomplished.

WARRANTY: It is Oreq policy to replace or credit our customer for defective parts returned due to workmanship or material failure during the first year of sale. Prior factory approval is required for returns, along with original receipt. Failure to follow manufacture recommended instructions for installation and or care voids all warranty. Oreq Corporation is not responsible for cost of removal of product or installation of replacement unit. Oreq is not responsible for shipping to or from facility or damage done by shipper.

WARNING: Improper chemical balance of pool water may cause corrosive conditions for metal water features. Oreq will not warranty products exposed to such water conditions or salt chlorine generators.

Show Us Your Stuff!

We know you work hard at your job and are proud of what you do. How about getting a little recognition for yourself and your company. Send us pictures of your projects using Custom Cascade products and we'll place them on our website, Facebook and Twitter for everyone to see, along with your information in the credits and a link to your website. We'll also add you to our builder locator tool on our website.



Custom Cascade Step Scupper shown above.

We're proud of what we make at Custom Cascade and we love seeing our finished water features in action. Send pictures to us by email to marketing@oreqcorp.com or mail the pictures to us at: Oreq Corporation, Marketing Department, 42306 Remington Ave, Temecula CA 92590. Include a brief description of the installation, the products being used and your company information so we can credit the photo.

You know what we can do, now show us what you can do!

Custom Cascade™

www.oreqcorp.com • 800.420.3255 Opt.2