



Built in conformance with NSF 50 and SPS 3 standards



**FEATURES**

- Adjustable collar
  - New weir clip lock secures the clips in the weir door
  - Weir plate with easy snap in and out locks
  - Self-contained gunite grip, water stop on face plate to prevent water leaks
  - Large self-contained basket with lock-in feature (will not float)
  - Pre-installed O-ring for float assembly
  - Underwater dampers on face plate for noise reduction on weir plate – especially on windy days
  - Super strong engineered polymer upper housing
  - Extra heavy duty PVC lower unit (no transitional glue required)
  - 2½" outside slip and 2" inside slip (outside skimmer)
  - 2" threads for pressure testing (inside skimmer)
  - Built-in overflow or fill line knock out
  - Upper housing has pre-cut rebar cut outs with pre-drilled holes for tie wire
  - Additional box inside skimmer box for basket, float assembly and weir plate (so assembly does not get lost on job site)
  - Skimmer Lid and Collar G154 UV tested
  - NSF 50 approved for commercial use, 25 GPM min, 55 GPM max – approved for residential use up to 100 GPM
  - Optional custom name/logo engraved on lid (requires minimum 100 piece lid order)
- 1 per case

Now available with three lid options:  
round, square or snap-in round/square



Optional vacuum plate with snap-in lug can be glued in under lid for easy storage p/n SK43xx

Part # SKR1xx

**STANDARD COLORS**

- SKR101 – White
- SKR102 – Black
- SKR103 – Light Gray
- SKR104 – Blue
- SKR105 – Dark Gray
- SKR108 – Tan

Snap-in Round/Square Lid and Collar (sold separately) p/n SK65xxx

Square Lid and Collar (sold separately) p/n SK64xxx

Available without lid and collar SKR1NL101 (white only)

**SPS 3 & NSF 50 Compliant**

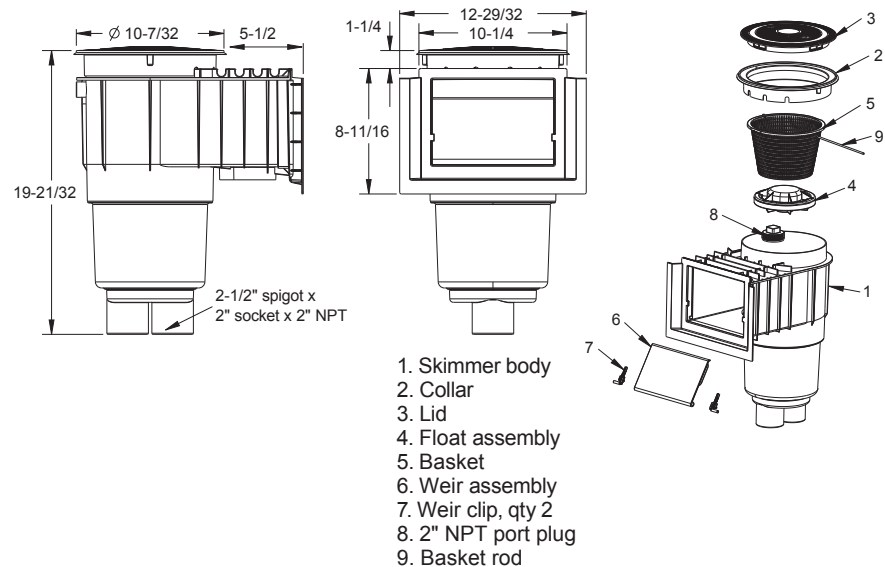

# SKIMMER OPTIONS

STANDARD COLORS



101 102 103 104 105 108

## Standard Waterstop Face Round Lid

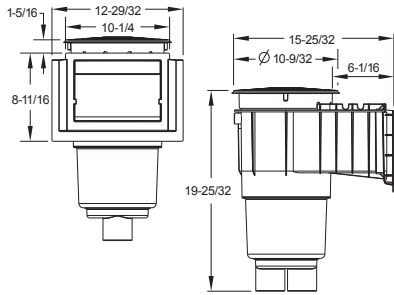

**SKR1xx**  
Standard Skimmer  
with Waterstop Face  
Dual Bottom Port  
2½" Spigot x 2" Socket

**SKR1xxD**  
Single Bottom Port  
4" Socket

**SKR1xxF**  
Single Bottom Port  
6" Socket

## Standard Flush Face Round Lid

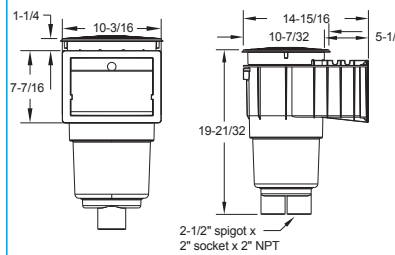

**SKR2xx**  
Standard Skimmer  
with Flush Face  
Dual Bottom Port  
2½" Spigot x 2" Socket

**SKR2xxD**  
Single Bottom Port  
4" Socket

**SKR2xxF**  
Single Bottom Port  
6" Socket

## Standard Waterstop Face Square Lid

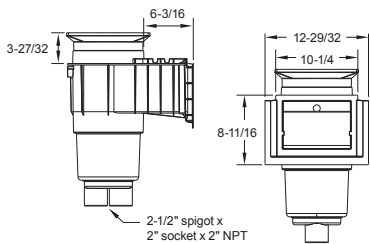

**SK64xxx** Square Lid and  
Collar (sold separately)

**SKR1xx**  
Standard Skimmer  
with Waterstop Face  
Dual Bottom Port  
2½" Spigot x 2" Socket

**SKR1xxD**  
Single Bottom Port  
4" Socket

**SKR1xxF**  
Single Bottom Port  
6" Socket

## Standard Flush Face Square Lid

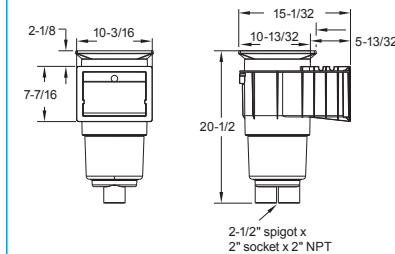

**SK64xxx** Square Lid and  
Collar (sold separately)

**SKR2xx**  
Standard Skimmer  
with Flush Face  
Dual Bottom Port  
2½" Spigot x 2" Socket

**SKR2xxD**  
Single Bottom Port  
4" Socket

**SKR2xxF**  
Single Bottom Port  
6" Socket

## Standard Waterstop Face Round/Square Snap-in Lid

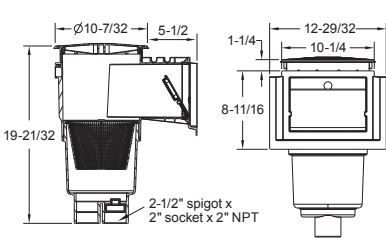

**SK65xxx** Snap-in  
Round/Square Lid and  
Collar (sold separately)

**SKR1xxx**  
with Float Assembly  
Dual Bottom Port  
2½" Spigot x 2" Socket

**SKR1xxxD**  
Single Bottom Port  
4" Socket

**SKR1xxxF**  
Single Bottom Port  
6" Socket

## Standard Flush Face Round/Square Snap-in Lid

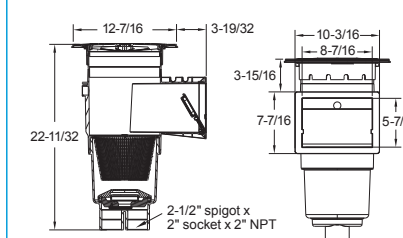

**SK65xxx** Snap-in  
Round/Square Lid and  
Collar (sold separately)

**SKR2xxx**  
with Float Assembly  
Dual Bottom Port  
2½" Spigot x 2" Socket

**SKR2xxxD**  
Single Bottom Port  
4" Socket

**SKR2xxxF**  
Single Bottom Port  
6" Socket

## Standard Waterstop Face Round/Square Snap-in Lid

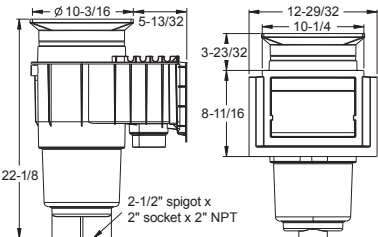

**SK65xxx** Snap-in  
Round/Square Lid and  
Collar (sold separately)

**SKR1xx-OZ**  
with Float Assembly  
and new Ozone Port  
Dual Bottom Port  
2½" Spigot x 2" Socket

## Standard Flush Face Round/Square Snap-in Lid

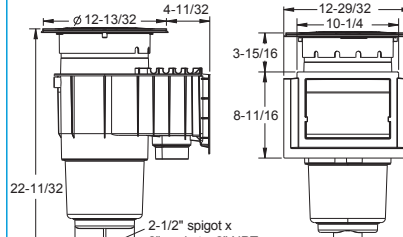

**SK65xxx** Snap-in  
Round/Square Lid and  
Collar (sold separately)

**SKR2xx-OZ**  
with Float Assembly  
and new Ozone Port  
Dual Bottom Port  
2½" Spigot x 2" Socket